



Triple PCI Express, Hot-Plug Controllers

General Description

The MAX5957/MAX5958 triple hot-plug controllers are designed for PCI Express (PCIe)[®] applications. These devices provide hot-plug control for 12V, 3.3V, and 3.3V auxiliary supplies of three PCIe slots. The MAX5957/MAX5958s' logic inputs/outputs allow interfacing directly with the system hot-plug management controller or through an SMBus[™] with an external I/O expander such as the MAX7313. An integrated debounced attention switch and present-detect signals simplify system design.

The MAX5957/MAX5958 drive six external n-channel MOSFETs to control the 12V and 3.3V main outputs. The 3.3V auxiliary outputs are controlled through 0.2Ω n-channel MOSFETs. Internal charge pumps provide the gate drive for the 12V outputs while the gate drive of the 3.3V output is driven by the 12V input supply clamped to 5.5V above the respective 3.3V main supply rail. The 3.3V auxiliary outputs are completely independent from the main outputs with their own charge pumps.

At power-up, the MAX5957/MAX5958 keep all the MOSFETs (internal and external) off until the supplies rise above their respective undervoltage lockout (UVLO) thresholds. Upon a turn-on command, the MAX5957/MAX5958 enhance the external and internal MOSFETs slowly with a constant gate current to limit the power-supply inrush current.

The MAX5957/MAX5958 actively limit the current to protect all outputs at all times and shut down if an overcurrent condition occurs. After an overcurrent fault condition, the MAX5957L/MAX5958L latch off while the MAX5957A/MAX5958A automatically restart after a restart time delay. The MAX5957/MAX5958 are offered in latch-off or auto-restart versions (see the *Selector Guide*).

The MAX5957/MAX5958 are available in a 56-pin TQFN package and operate over the -40°C to +85°C temperature range.

Applications

Servers
Desktop Mobile Server Platforms
Workstations
Embedded Devices

Features

- ◆ PCIe Compliant
- ◆ Hot Swap 12V, 3.3V, and 3.3V Auxiliary for 3 PCIe Slots
- ◆ Integrated Power MOSFETs for Auxiliary Supply Rails
- ◆ Controls di/dt and dV/dt
- ◆ Active Current Limiting Protects Against Overcurrent/Short-Circuit Conditions
- ◆ Programmable Current-Limit Timeout
- ◆ PWRGD Signal Outputs with Programmable Power-On Reset (POR) (160ms Default)
- ◆ Latched FAULT Signal Output After Overcurrent or Overtemperature Fault
- ◆ Attention Switch Inputs/Outputs with 4ms Debounce
- ◆ Present-Detect Inputs
- ◆ Force-On Inputs Facilitate Testing/Debug
- ◆ Thermal Shutdown
- ◆ Allow Control Through SMBus with an I/O Expander

Ordering Information

PART	TEMP RANGE	PIN-PACKAGE	PKG CODE
MAX5957AETN+	-40°C to +85°C	56 Thin QFN	T5677-1
MAX5957LETN+	-40°C to +85°C	56 Thin QFN	T5677-1
MAX5958AETN+	-40°C to +85°C	56 Thin QFN	T5677-1
MAX5958LETN+	-40°C to +85°C	56 Thin QFN	T5677-1

+Denotes a lead-free package.

Pin Configuration and Typical Application Circuit appear at end of data sheet.

PCI Express is a registered trademark of PCI-SIG Corp.
SMBus is a trademark of Intel Corp.

Selector Guide

PART	LATCH OFF	AUTORESTART	GUARANTEED AUX CURRENT (mA)
MAX5957AETN+		√	375
MAX5957LETN+	√		375
MAX5958AETN+		√	550
MAX5958LETN+	√		550



Triple PCI Express, Hot-Plug Controllers

ABSOLUTE MAXIMUM RATINGS

(All voltages referenced to GND, unless otherwise noted.)

12VIN	-0.3V to +14V
12G ₋	-0.3V to (V _{12VIN} + 6V)
12S ₊ , 12S ₋ , 3.3G ₋	-0.3V to (V _{12VIN} + 0.3V)
3.3VAUXIN, ON ₋ , FAULT ₋ , PWRGD ₋	-0.3V to +6V
PGND	-0.3V to +0.3V
All Other Pins	-0.3V to (V _{3.3VAUXIN} + 0.3V)

Continuous Power Dissipation (T_A = +70°C)

56-Pin Thin QFN (derate 40mW/°C above +70°C)3200mW
Operating Temperature Range-40°C to +85°C
Junction Temperature+150°C
Storage Temperature Range-65°C to +150°C
Lead Temperature (soldering, 10s)+300°C

Stresses beyond those listed under "Absolute Maximum Ratings" may cause permanent damage to the device. These are stress ratings only, and functional operation of the device at these or any other conditions beyond those indicated in the operational sections of the specifications is not implied. Exposure to absolute maximum rating conditions for extended periods may affect device reliability.

ELECTRICAL CHARACTERISTICS

(V_{12VIN} = V_{12S+} = V_{12S-} = 12V, V_{3.3S+} = V_{3.3S-} = V_{3.3AUXIN} = V_{ON-} = V_{AUXON-} = V_{FON-} = 3.3V, PWRGD₋ = FAULT₋ = PORADJ = TIM = OUTPUT₋ = 12G₋ = 3.3G₋ = OPEN, INPUT₋ = PRES-DET₋ = PGND = GND, T_A = T_J = -40°C to +85°C, unless otherwise noted. Typical values are at T_A = T_J = +25°C.) (Note 1)

PARAMETER	SYMBOL	CONDITIONS	MIN	TYP	MAX	UNITS
12V SUPPLY (MAIN)						
12V Supply Input-Voltage Range	V _{12VIN}		10.8	12	13.2	V
12V Undervoltage Lockout	V _{12UVLO}	V _{12VIN} rising	9.5	10	10.5	V
		Hysteresis		0.1		
12V Undervoltage Lockout Deglitch Time	t _{DEG,UVLO}	V _{12IN} falling below V _{12UVLO} to UVLO assertion		30		μs
12V Supply Current	I _{12VIN}	V _{12VIN} = 13.2V		1	2.5	mA
12VIN CONTROL						
12VIN Current-Limit Threshold (V _{12S+} - V _{12S-})	V _{12ILIM}		49	54	59	mV
12G ₋ Gate Charge Current	I _{12G, CHG}	V _{12G-} = GND	4	5	6	μA
12G ₋ Gate Discharge Current	I _{12G-, DIS}	Normal turn-off, ON ₋ = GND, V _{12G-} = 2V	50	150	250	μA
		Output short-circuit condition, strong gate pulldown to regulation, (V _{12S+} - V _{12S-}) ≥ 1V, V _{12G-} = 5V	60	120	200	mA
12G ₋ Gate High Voltage (V _{12G-} - V _{12VIN})	V _{12G, H}	I _{12G-} = 1μA	4.8	5.3	5.8	V
12G ₋ Threshold Voltage for PWRGD ₋ Assertion	V _{PGTH12}	Referred to V _{12VIN} , I _{12G-} = 1μA (Note 2)	3.0	4.0	4.8	V
12S ₋ Input Bias Current					1	μA
12S ₊ Input Bias Current				10	30	μA
3.3V SUPPLY (MAIN)						
3.3V Supply Voltage Range	V _{3.3S+}		3.0	3.3	3.6	V
Undervoltage Lockout (Note 3)		3.3SA+ rising	2.50	2.65	2.78	V
		Hysteresis		30		mV

Triple PCI Express, Hot-Plug Controllers

MAX5957/MAX5958

ELECTRICAL CHARACTERISTICS (continued)

($V_{12VIN} = V_{12S+} = V_{12S-} = 12V$, $V_{3.3S+} = V_{3.3S-} = V_{3.3AUXIN} = V_{ON-} = V_{AUXON-} = V_{FON-} = 3.3V$, $\overline{PWRGD-} = \overline{FAULT-} = \overline{PORADJ} = \overline{TIM} = \overline{OUTPUT-} = 12G- = 3.3G- = \text{OPEN}$, $\overline{INPUT-} = \overline{PRES-DET-} = \text{PGND} = \text{GND}$, $T_A = T_J = -40^{\circ}\text{C}$ to $+85^{\circ}\text{C}$, unless otherwise noted. Typical values are at $T_A = T_J = +25^{\circ}\text{C}$.) (Note 1)

PARAMETER	SYMBOL	CONDITIONS	MIN	TYP	MAX	UNITS	
3.3V CONTROL							
3.3V Current-Limit Threshold ($V_{3.3S+} - V_{3.3S-}$)	$V_{3.3ILIM}$		17	20	23	mV	
3.3G_ Gate Charge Current	$I_{3.3G_CHG}$	$V_{3.3G-} = \text{GND}$	4	5	6	μA	
3.3G_ Gate Discharge Current	$I_{3.3G_DIS}$	Normal turn-off, $\text{ON-} = \text{GND}$, $V_{3.3G-} = 2V$	50	150	250	μA	
		Output short-circuit condition, strong gate pulldown to regulation, $V_{3.3S+} - V_{3.3S-} \geq 1V$, $V_{3.3G-} = 5V$	90	150	250	mA	
3.3G_ Gate High Voltage ($V_{3.3G-} - V_{3.3S+}$)	$V_{3.3G_H}$	$I_{\text{SOURCE}} = 1\mu\text{A}$	4.5	5.5	6.8	V	
3.3G_ Threshold Voltage for $\overline{PWRGD-}$ Assertion	$V_{PGTH3.3}$	Referred to $V_{3.3AUXIN}$, $I_{3.3G-} = 1\mu\text{A}$ (Note 2)	3.0	4.0	4.5	V	
3.3S_ Input Bias Current					1	μA	
3.3S_+ Input Bias Current				20	60	μA	
3.3V AUXILIARY SUPPLY							
3.3VAUXIN Supply Input Voltage Range	$V_{3.3AUXIN}$		3.0	3.3	3.6	V	
3.3VAUXIN Undervoltage Lockout	$V_{3.3VAUXUVLO}$	$V_{3.3VAUXIN}$ rising	2.50	2.65	2.78	V	
		Hysteresis		30		mV	
3.3VAUXIN Supply Current		$V_{3.3VAUXIN} = 3.6V$		2.5	5	mA	
3.3VAUXIN to 3.3VAUXO Maximum Dropout		$I_{3.3VAUXO} = 375\text{mA}$ (MAX5957)			225	mV	
		$I_{3.3VAUXO} = 550\text{mA}$ (MAX5958)			280		
3.3VAUXO_ Current-Limit Threshold		3.3VAUXO_ shorted to GND	MAX5957	376	450	564	mA
			MAX5958	560	700	850	
3.3VAUXO_ Threshold for $\overline{PWRGD-}$ Assertion ($V_{3.3VAUXIN} - V_{3.3VAUXO}$)	$V_{PGTH3.3AUX}$	(Note 2)			400	mV	
LOGIC SIGNALS							
Input-Logic Threshold (ON- , $\overline{\text{FON-}}$, AUXON- , $\overline{\text{PRES-DET-}}$, $\overline{\text{INPUT-}}$)		Rising edge	1.0		2.0	V	
		Hysteresis		25		mV	
Input Bias Current (ON- , AUXON- , $\overline{\text{INPUT-}}$)					1	μA	
$\overline{\text{FON-}}$, $\overline{\text{PRES-DET-}}$ Internal Pullup			25	50	75	$\text{k}\Omega$	
ON- , AUXON- High-to-Low Deglitch Time				4		μs	

Triple PCI Express, Hot-Plug Controllers

ELECTRICAL CHARACTERISTICS (continued)

($V_{12VIN} = V_{12S+} = V_{12S-} = 12V$, $V_{3.3S+} = V_{3.3S-} = V_{3.3AUXIN} = V_{ON-} = V_{AUXON-} = V_{FON-} = 3.3V$, $\overline{PWRGD-} = \overline{FAULT-} = \text{PORADJ} = \text{TIM} = \text{OUTPUT-} = 12G- = 3.3G- = \text{OPEN}$, $\text{INPUT-} = \text{PRES-DET-} = \text{PGND} = \text{GND}$, $T_A = T_J = -40^{\circ}\text{C}$ to $+85^{\circ}\text{C}$, unless otherwise noted. Typical values are at $T_A = T_J = +25^{\circ}\text{C}$.) (Note 1)

PARAMETER	SYMBOL	CONDITIONS	MIN	TYP	MAX	UNITS
PRES-DET_ High-to-Low Deglitch Time	t _{DEG}		3	5	7	ms
$\overline{PWRGD-}$ Power-On Reset Deglitch Time (Note 2)	t _{POR_HL}	V _{PORADJ} = GND			1	μs
		PORADJ = unconnected	90	160	250	ms
		R _{PORADJ} = 20kΩ	35	55	75	
		R _{PORADJ} = 100kΩ	145	265	380	
		R _{PORADJ} = 200kΩ		530		
$\overline{PWRGD-}$ Low-to-High Deglitch Time	t _{POR_LH}			4		μs
$\overline{PWRGD-}$, $\overline{FAULT-}$ Output Low Voltage		I _{SINK} = 2mA			0.1	V
		I _{SINK} = 30mA			0.8	
$\overline{PWRGD-}$, $\overline{FAULT-}$ Output High Leakage Current		$\overline{PWRGD-}$, $\overline{FAULT-} = 5.5V$			1	μA
$\overline{FAULT-}$ Timeout	t _{FAULT}	TIM = open	5.5	11	17	ms
		R _{TIM} = 15kΩ	1.4	2.6	3.8	
		R _{TIM} = 120kΩ	12	22	32	
		R _{TIM} = 300kΩ		53		
$\overline{FAULT-}$ Timeout During Startup	t _{SU}			2 x t _{FAULT}		ms
Autorestart Delay Time	t _{RESTART}			64 x t _{FAULT}		ms
Fault Reset Minimum Pulse Width	t _{RESET}	(Note 4)		100		μs
Thermal Shutdown Threshold	t _{SD}	T _J rising		150		°C
Thermal Shutdown Hysteresis				20		
OUT_ Debounce Time	t _{DBC}		2.6	4.4	6.2	ms
OUT_ Voltage High		I _{SOURCE} = 2mA		V _{3.3AUXIN} - 0.3	V _{3.3AUXIN}	V
OUT_ Voltage Low		I _{SINK} = 2mA			0.4	V

Note 1: All devices are 100% production tested at $T_A = +25^{\circ}\text{C}$. Limits over temperature are guaranteed by design.

Note 2: $\overline{PWRGD-}$ asserts a time t_{POR_HL} after V_{PGTH12}, V_{PGTH3.3}, and V_{PGTH3.3AUX} conditions are met.

Note 3: The UVLO for the 3.3V supply is sensed at 3.3S₊.

Note 4: This is the time that ON₋ or AUXON₋ must stay low when resetting a fault condition.

Triple PCI Express, Hot-Plug Controllers

Typical Operating Characteristics

($V_{12VIN} = V_{12S+} = 12V$, $V_{3.3S+} = V_{3.3S-} = V_{3.3AUXIN} = V_{ON-} = V_{AUXON-} = V_{FON-} = 3.3V$, $\overline{PWRGD-} = \overline{FAULT-} = \overline{PORADJ} = \overline{TIM} = \overline{OUTPUT-} = \overline{OPEN}$, $\overline{INPUT-} = \overline{PRES-DET-} = \overline{PGND} = \overline{GND}$. See the *Typical Application Circuit*.)

MAX5957/MAX5958

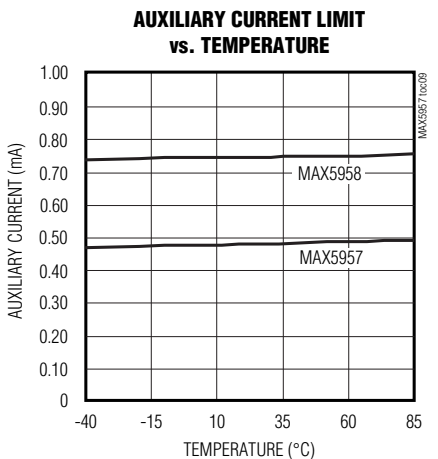
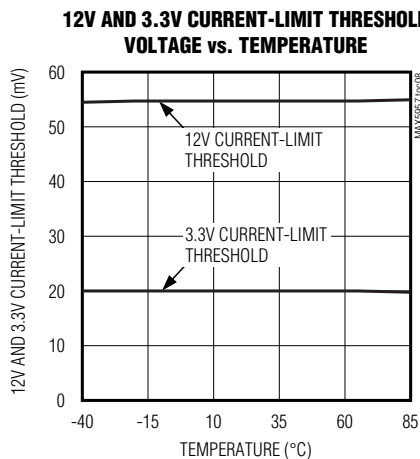
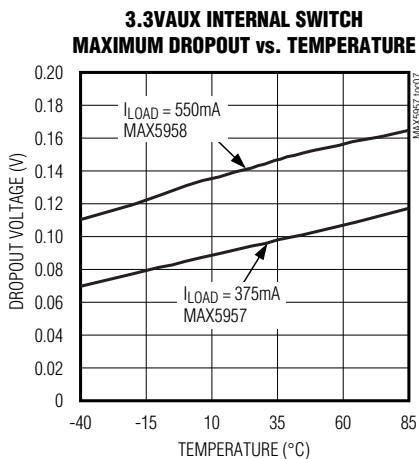
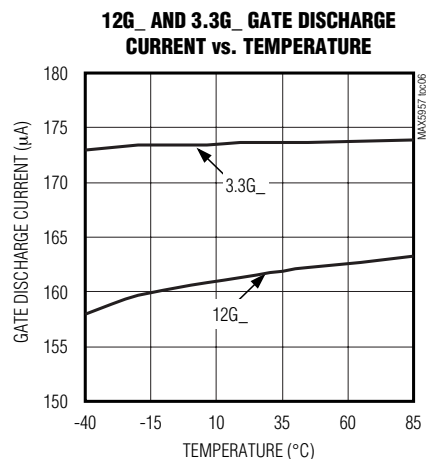
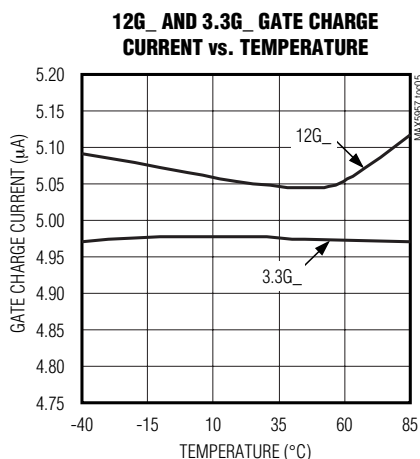
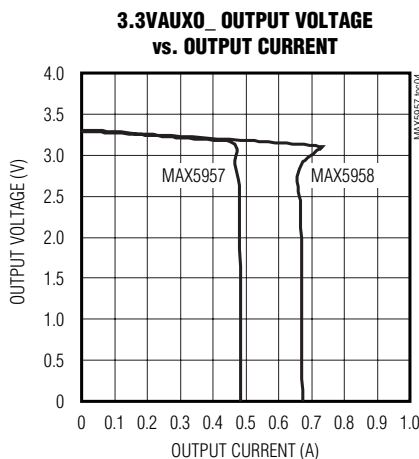
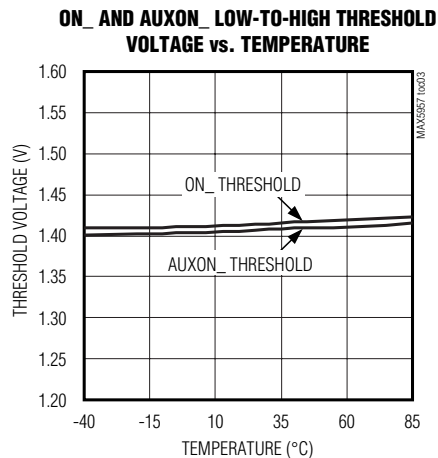
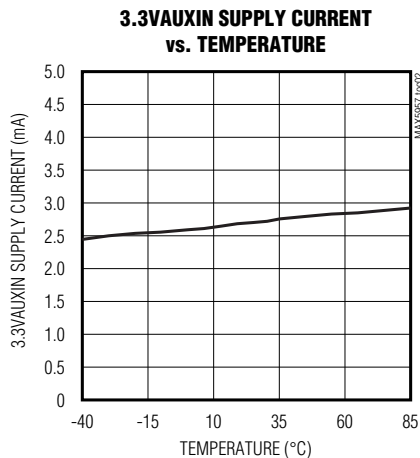
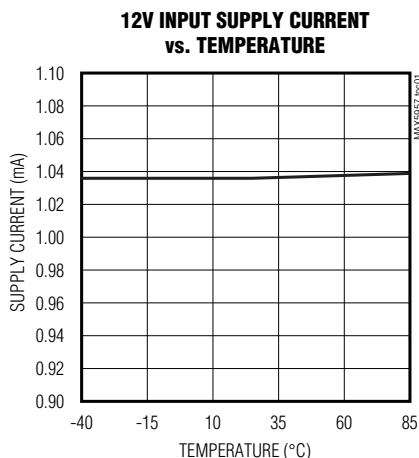

Triple PCI Express, Hot-Plug Controllers

Typical Operating Characteristics (continued)

($V_{12VIN} = V_{12S+} = 12V$, $V_{3.3S+} = V_{3.3S-} = V_{3.3AUXIN} = V_{ON-} = V_{AUXON-} = V_{FON-} = 3.3V$, $\overline{PWRGD-} = \overline{FAULT-} = \overline{PORADJ} = \overline{TIM} = \overline{OUTPUT-} = \overline{OPEN}$, $\overline{INPUT-} = \overline{PRES-DET-} = \overline{PGND} = \overline{GND}$. See the *Typical Application Circuit*.)

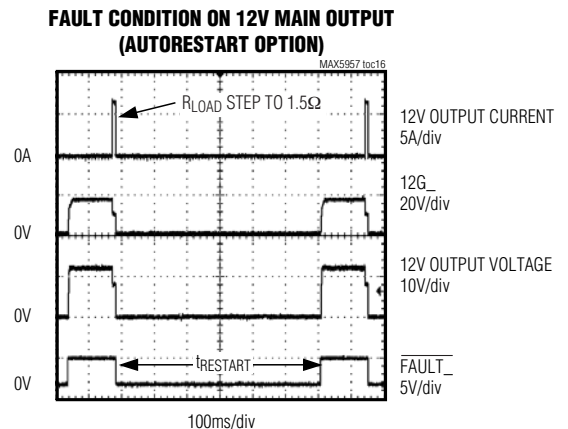
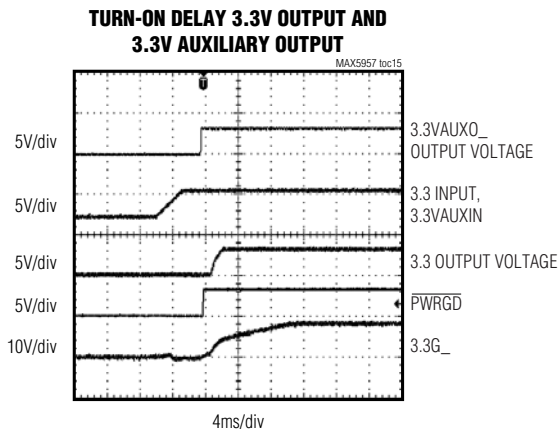
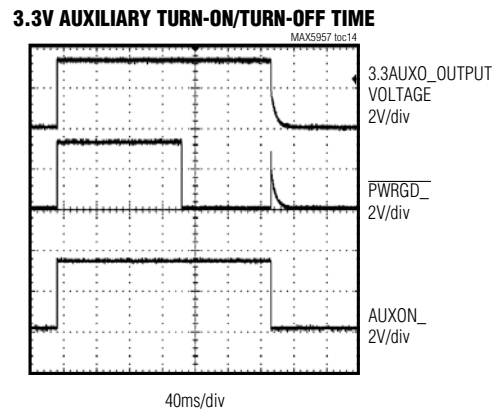
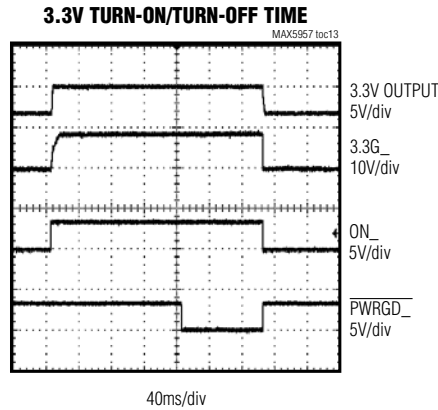
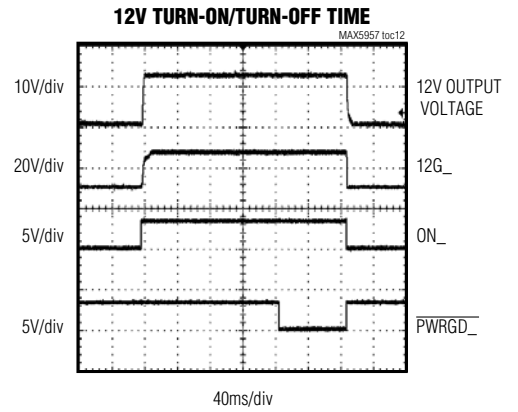
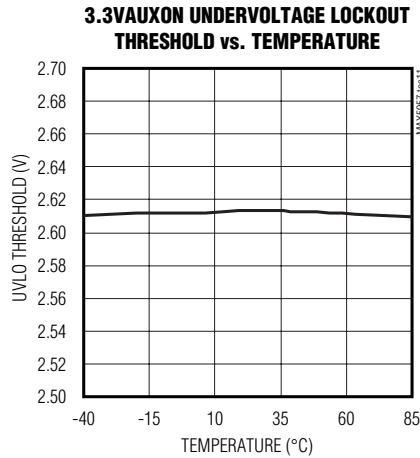
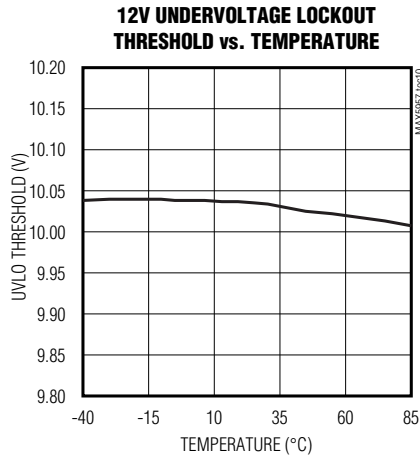

Triple PCI Express, Hot-Plug Controllers

Typical Operating Characteristics (continued)

($V_{12S+} = V_{12S-} = 12V$, $V_{3.3S+} = V_{3.3S-} = V_{3.3AUXIN} = V_{ON-} = V_{AUXON-} = V_{FON-} = 3.3V$, $\overline{PWRGD-} = \overline{FAULT-} = \text{PORADJ} = \text{TIM} = \text{OUTPUT-} = \text{OPEN}$, $\text{INPUT-} = \overline{\text{PRES-DET-}} = \text{PGND} = \text{GND}$. See the *Typical Application Circuit*.)

FAULT CONDITION ON 3.3V MAIN OUTPUT (AUTORESTART OPTION)

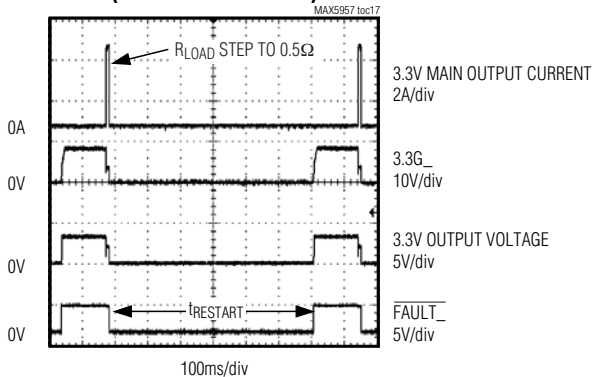

FAULT CONDITION ON AUXILIARY OUTPUT (AUTORESTART OPTION)

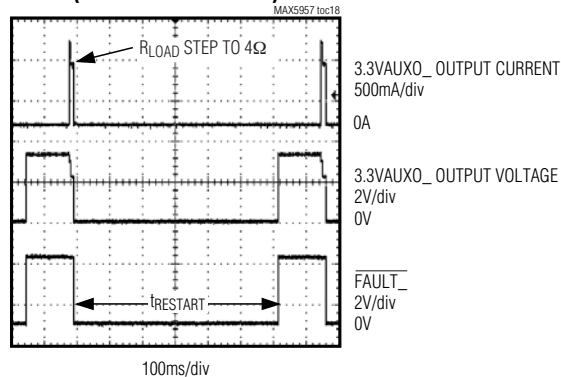

FAULT CONDITION ON 12V OUTPUT (LATCH OPTION MAX5958)

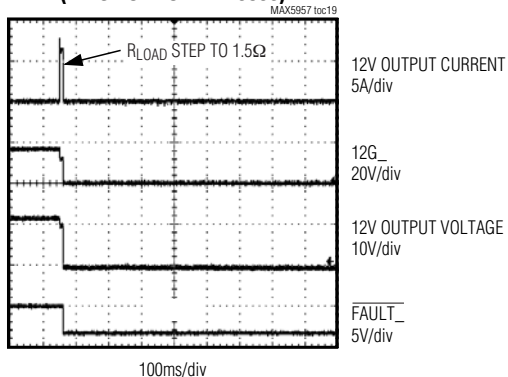

FAULT CONDITION ON 12V OUTPUT

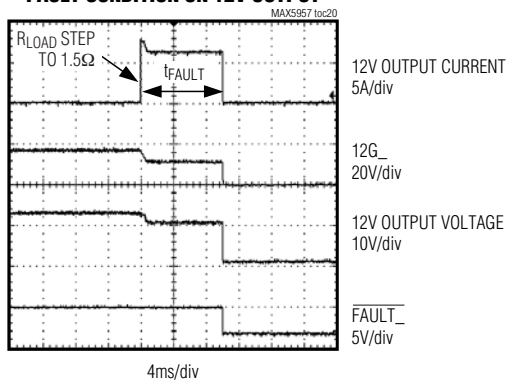

FAULT CONDITION ON 3.3V OUTPUT (LATCHOFF OPTION)

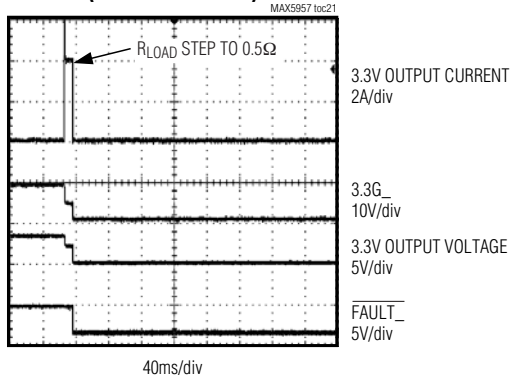

FAULT CONDITION ON 3.3V MAIN OUTPUT

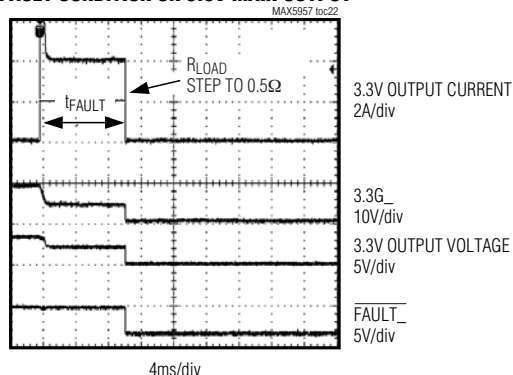

MAX5957/MAX5958

Triple PCI Express, Hot-Plug Controllers

Typical Operating Characteristics (continued)

($V_{12VIN} = V_{12S+} = 12V$, $V_{3.3S+} = V_{3.3S-} = V_{3.3AUXIN} = V_{ON-} = V_{AUXON-} = V_{FON-} = 3.3V$, $\overline{PWRGD-} = \overline{FAULT-} = \overline{PORADJ} = \overline{TIM} = \overline{OUTPUT-} = \overline{OPEN}$, $\overline{INPUT-} = \overline{PRES-DET-} = \overline{PGND} = \overline{GND}$. See the *Typical Application Circuit*.)

FAULT CONDITION ON AUXILIARY OUTPUT (LATCHOFF OPTION)

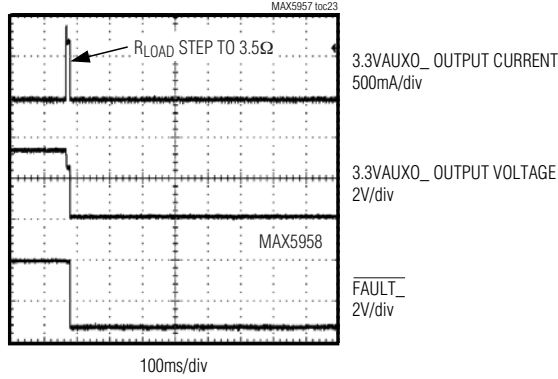

FAULT CONDITION ON AUXILIARY OUTPUT

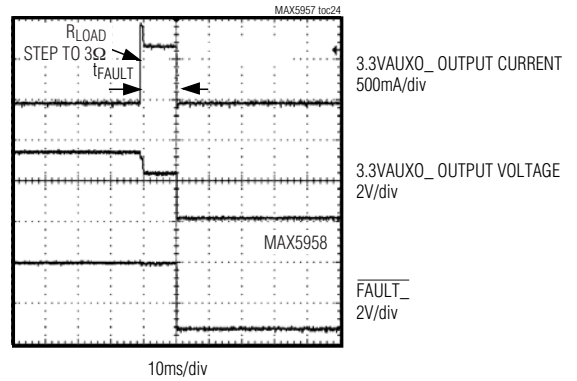

SHORT CIRCUIT ON 12V MAIN OUTPUT

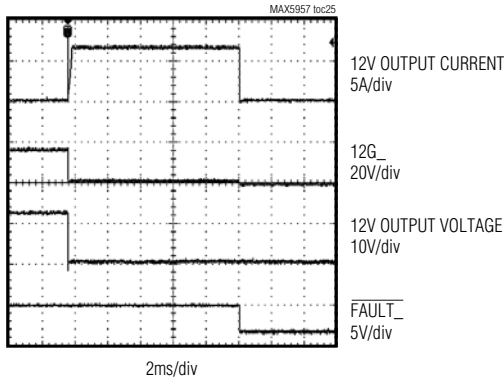

SHORT CIRCUIT ON 12V MAIN OUTPUT

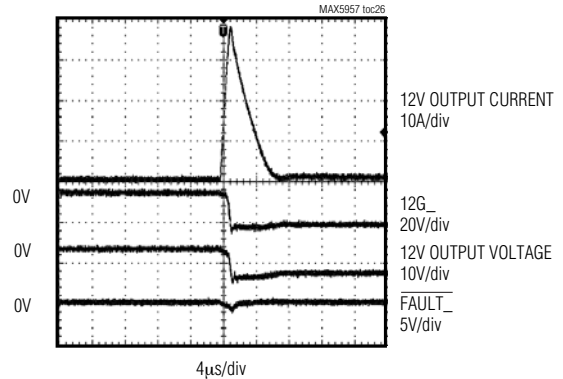

SHORT CIRCUIT ON 3.3V MAIN OUTPUT

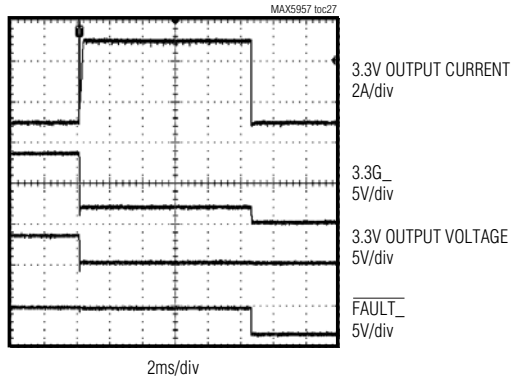

SHORT CIRCUIT ON 3.3V MAIN OUTPUT

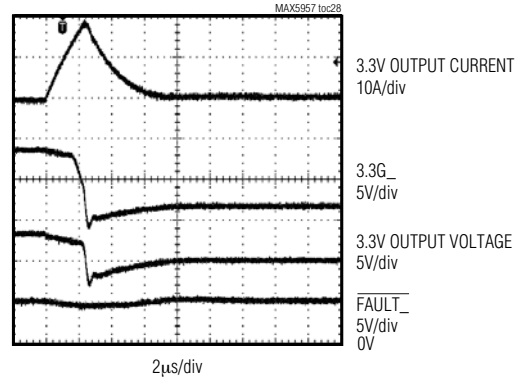

Triple PCI Express, Hot-Plug Controllers

Typical Operating Characteristics (continued)

($V_{12VIN} = V_{12S+} = 12V$, $V_{3.3S+} = V_{3.3S-} = V_{3.3AUXIN} = V_{ON-} = V_{AUXON-} = V_{FON-} = 3.3V$, $\overline{PWRGD-} = \overline{FAULT-} = \overline{PORADJ} = \overline{TIM} = \overline{OUTPUT-} = \overline{OPEN}$, $\overline{INPUT-} = \overline{PRES-DET-} = \overline{PGND} = \overline{GND}$. See the *Typical Application Circuit*.)

**SHORT CIRCUIT ON
3.3AUXO_ AUXILIARY OUTPUT**

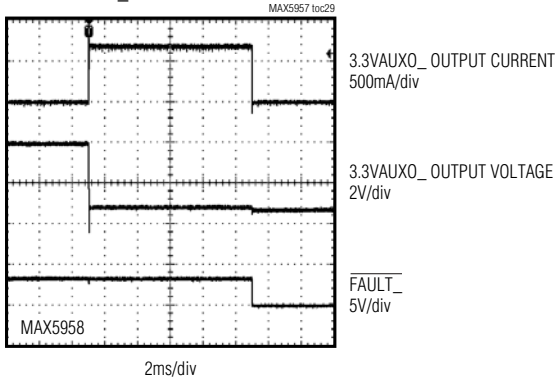

**SHORT CIRCUIT ON 3.3VAUXO_
AUXILIARY OUTPUT**

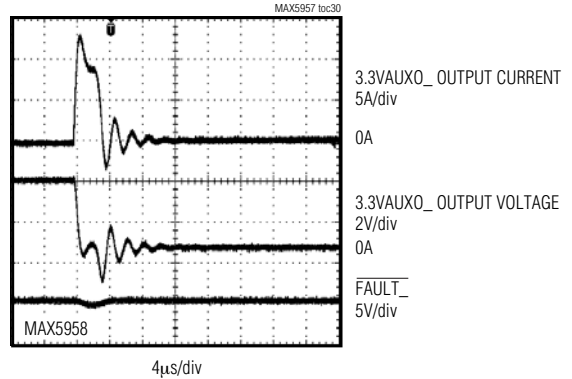

**POWER-UP INTO FAULT
(AUXILIARY SUPPLY)**

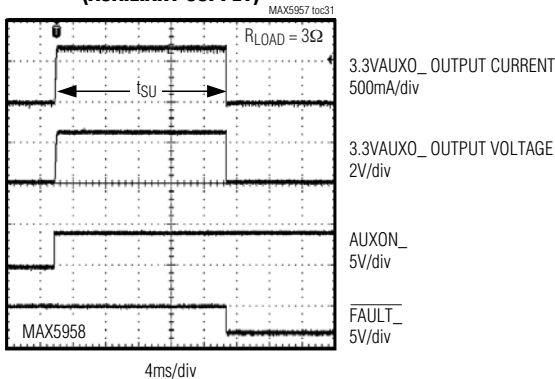

POWER-UP INTO FAULT (3.3V MAIN)

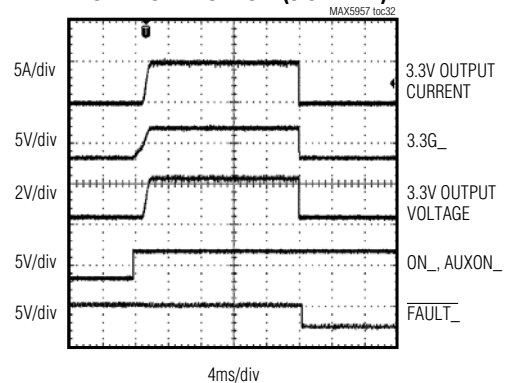

**POWER-UP INTO FAULT
(12V MAIN OUTPUT)**

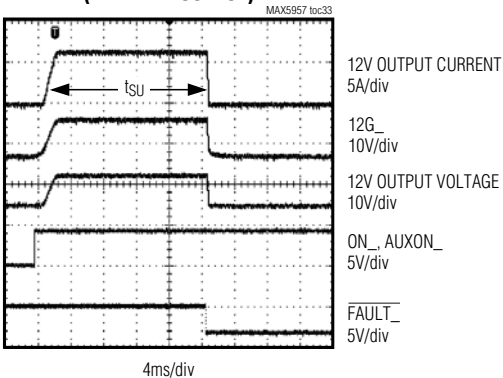

PRESENT-DETECT (ON/OFF) OPERATION

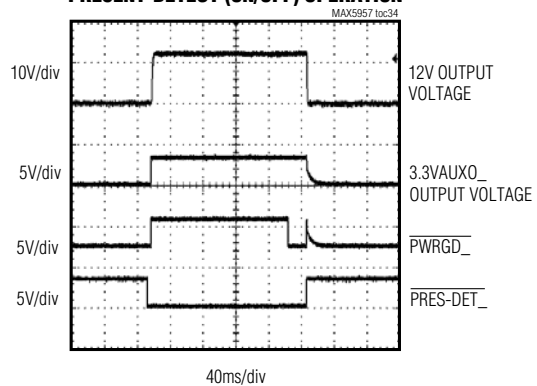

MAX5957/MAX5958

Triple PCI Express, Hot-Plug Controllers

Typical Operating Characteristics (continued)

($V_{12VIN} = V_{12S+} = 12V$, $V_{3.3S+} = V_{3.3S-} = V_{3.3AUXIN} = V_{ON-} = V_{AUXON-} = V_{FON-} = 3.3V$, $\overline{PWRGD-} = \overline{FAULT-} = \text{PORADJ} = \text{TIM} = \text{OUTPUT-} = \text{OPEN}$, $\text{INPUT-} = \overline{\text{PRES-DET-}} = \text{PGND} = \text{GND}$. See the *Typical Application Circuit*.)

PRESENT-DETECT (ON/OFF) OPERATION

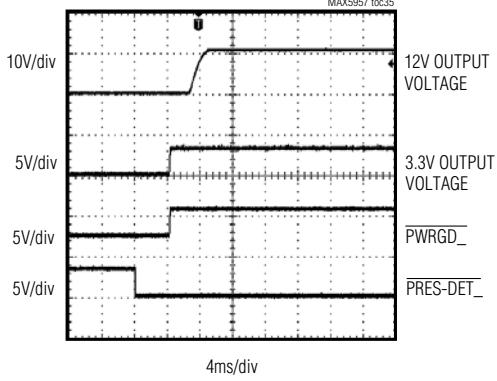

FORCED-ON (ON/OFF) OPERATION

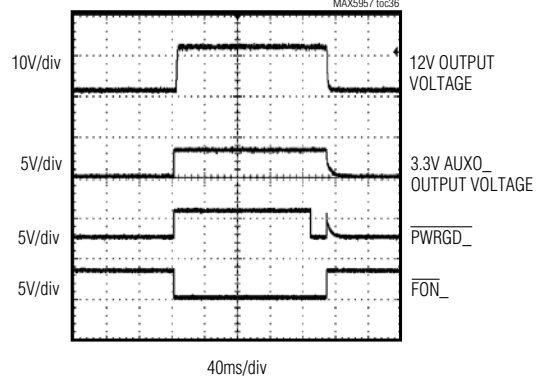

FORCED-ON (ON/OFF) OPERATION

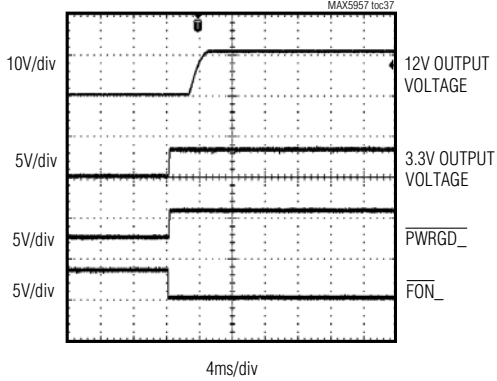

DEBOUNCED INPUT/OUTPUT OPERATION

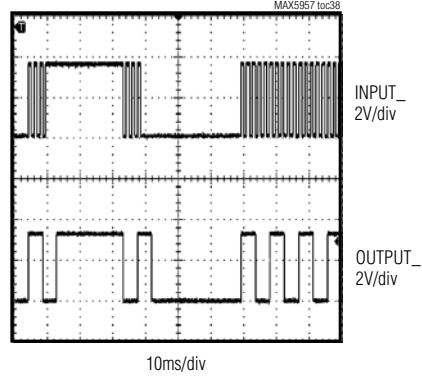

POWER-ON-RESET TIME vs. PORADJ RESISTOR

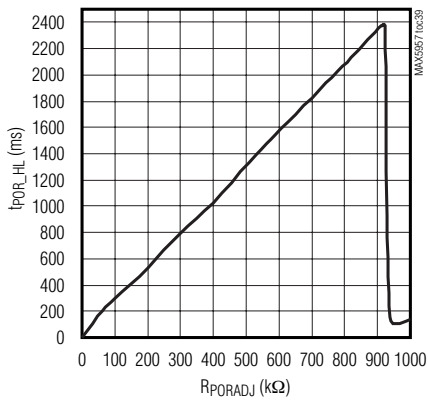

tFAULT TIME DELAY vs. TIM RESISTOR

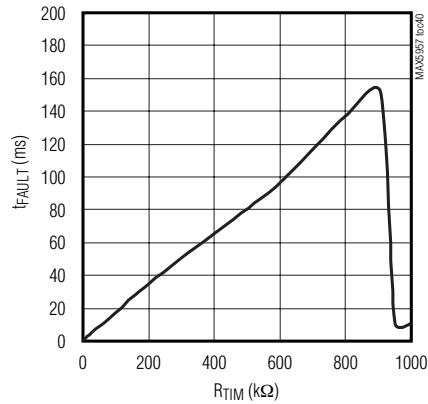

Triple PCI Express, Hot-Plug Controllers

Pin Description

PIN	NAME	FUNCTION
1	12SB-	Slot B 12V Negative Current-Sense Input. Connect 12SB- to the negative side of the current-sense resistor using the Kelvin-sensing technique to ensure accurate current sensing.
2	12SB+	Slot B 12V Positive Current-Sense Input. Connect the positive terminal of the current-sense resistor to 12SB+ using the Kelvin-sensing technique to ensure accurate current sensing.
3	AUXONB	Slot B 3.3V Auxiliary Output Enable. A logic-high at AUXONB turns on the slot B auxiliary output.
4	ONB	Slot B 12V and 3.3V Main Outputs Enable. A logic-high at ONB turns on the 12V and 3.3V main outputs of slot B (see Table 2).
5	INPUT1	Digital Logic Gate Input 1
6	OUTPUT1	Digital Output One. 4ms debounced digital output of INPUT1.
7	INPUT2	Digital Logic Gate Input 2
8	OUTPUT2	Digital Output 2. 4ms debounced digital output of INPUT2.
9, 27	GND	Ground
10	$\overline{\text{FONC}}$	Slot C Forced-On Input. $\overline{\text{FONC}}$ has a 50k Ω internal pullup to 3.3VAUXIN. A logic-low on $\overline{\text{FONC}}$ turns on all slot C outputs as long as the power inputs are within their operating range, regardless of the status of the other input signals. Leave $\overline{\text{FONC}}$ unconnected for normal operation.
11	$\overline{\text{PRES-DETC}}$	Slot C Present-Detect Input. $\overline{\text{PRES-DETC}}$ accepts inputs from PRSNT-# on a PCIe connector. $\overline{\text{PRES-DETC}}$ has an internal 50k Ω pullup to 3.3VAUXIN. When $\overline{\text{PRES-DETC}}$ is low, the outputs follow the command from ONC and AUXONC after a 4ms debounced time. When $\overline{\text{PRES-DETC}}$ goes from low to high, all outputs of the respective slot shut down with no delay.
12	ONC	Slot C 12V and 3.3V Main Outputs Enable. A logic-high at ONC turns on the 12V and 3.3V main outputs of slot C (see Table 2).
13	AUXONC	Slot C 3.3V Auxiliary Output Enable. A logic-high at AUXONC turns on the slot C auxiliary output.
14	12SC+	Slot C 12V Positive Current-Sense Input. Connect the positive terminal of the current-sense resistor to 12SC+ using the Kelvin-sensing technique to ensure accurate current sensing.
15	12SC-	Slot C 12V Negative Current-Sense Input. Connect 12SC- to the negative side of the current-sense resistor using the Kelvin-sensing technique to ensure accurate current sensing.
16	12GC	Slot C 12V Gate-Drive Output. Connect 12GC to the gate of slot C's 12V MOSFET. At power-up, 12GC is raised to the internal charge-pump voltage level by a constant current.
17	3.3SC+	Slot C 3.3V Positive Current-Sense Input. Connect the positive side of the current-sense resistor to 3.3SC+ using the Kelvin-sensing technique to ensure accurate current sensing.
18	3.3SC-	Slot C 3.3V Negative Current-Sense Input. Connect to the negative side of the sense resistor using the Kelvin-sensing technique to ensure accurate current sensing.
19	3.3GC	Slot C 3.3V Gate-Drive Output. Connect 3.3GC to the gate of slot C's 3.3V MOSFET. At power-up, 3.3GC is charged to 5.5V above the 3.3V supply by a constant current derived from V _{12VIN} . V _{3.3GC} 's rise time is determined by the external gate capacitance.
20	$\overline{\text{FAULTC}}$	Open-Drain Fault Output Signal. $\overline{\text{FAULTC}}$ latches active low whenever slot C outputs are shut down due to a fault. A fault is either of: <ul style="list-style-type: none"> An overcurrent condition lasting longer than the overcurrent timeout. A device over the temperature condition. If the fault is detected in the main outputs, $\overline{\text{FAULTC}}$ must be reset by toggling the ONC input. If the fault is in the auxiliary output, $\overline{\text{FAULTC}}$ must be reset by toggling both ONC and AUXONC. For the autorestart version, $\overline{\text{FAULTC}}$ is reset when the part initiates the next power-on cycle.
21	$\overline{\text{PWRGDC}}$	Open-Drain Power-Good Output. $\overline{\text{PWRGDC}}$ goes low 160ms after all outputs of slot C reach their final value and the power MOSFETs are fully enhanced.

MAX5957/MAX5958

Triple PCI Express, Hot-Plug Controllers

Pin Description (continued)

PIN	NAME	FUNCTION
22	3.3AUXOC	Slot C 3.3V Auxiliary Power-Supply Output
23, 48, 49	3.3VAUXIN	3.3V Auxiliary Supply Input. 3.3VAUXIN is the input to a charge pump that drives the internal MOSFETs connecting 3.3VAUXIN to 3.3AUXO_. V _{3.3AUXIN} is also used to power the internal control logic and analog references of the MAX5957/MAX5958 and must always be connected to a supply between 3V and 3.6V. Bypass 3.3AUXIN with a 0.1μF capacitor to GND.
24, 46	PGND	Power Ground. Connect externally to GND.
25	TIM	Overcurrent Timeout Programming Input. Connect a resistor between 500Ω and 500kΩ from TIM to GND to program t _{FAULT} . Leave TIM unconnected for a default timeout of 11ms.
26	PORADJ	Power-On-Reset Programming Input. Connect a resistor between 500Ω and 500kΩ from PORADJ to GND to program the POR timing. Leave unconnected for a default value of 160ms. Connect PORADJ to GND to completely skip the POR time delay for P _{WGD} _. Connect PORADJ to GND to completely skip the POR time delay for P _{WRGD} _ assertion.
27	GND	Ground
28	12VIN	12V Supply Input. V _{12VIN} drives the gates of the MOSFETs connected to 3.3G_. 12VIN powers an internal charge pump that drives the gates of the MOSFETs connected to 12G_. Bypass 12VIN with a 1μF capacitor to GND.
29	N.C.	No Connection. Not internally connected.
30	PRES-DETB	Slot B Present-Detect Input. PRES-DETB accepts inputs from PRSNT#_# on a PCIe connector. PRES-DETB has an internal 50kΩ pullup to 3.3VAUXIN. When PRES-DETB is low, the outputs follow the command from ONB and AUXONB after a 4ms debounced time. When PRES-DETB goes from low to high, all outputs of the respective slot shut down with no delay.
31	FONB	Slot B Forced-On Input. FONB has a 50kΩ internal pullup to 3.3VAUXIN. A logic-low on FONB turns on all slot B outputs as long as the power inputs are within their operating range, regardless of the status of the other input signals. Leave FONB unconnected for normal operation.
32	PRES-DETA	Slot A Present-Detect Input. PRES-DETA accepts inputs from PRSNT#_# on a PCIe connector. PRES-DETA has an internal 50kΩ pullup to 3.3VAUXIN. When PRES-DETA is low, the outputs follow the command from ONA and AUXONA after a 4ms debounced time. When PRES-DETA goes from low to high, all outputs of the respective slot shut down with no delay.
33	FONA	Slot A Forced-On Input. FONA has a 50kΩ internal pullup to 3.3VAUXIN. A logic-low on FONA turns on all slot A outputs as long as the power inputs are within their operating range, regardless of the status of the other input signals. Leave FONA unconnected for normal operation.
34	OUTPUT3	Digital Output 3. 4ms debounced digital output of INPUT3.
35	INPUT3	Digital Logic Gate Input 3
36	ONA	Slot A 12V and 3.3V Outputs Enable. A logic-high at ONA turns on the 12V and 3.3V outputs of slot A (see Table 2).
37	AUXONA	Slot A 3.3V Auxiliary Output Enable. A logic-high at AUXONA turns on the slot A auxiliary output.
38	12SA+	Slot A 12V Positive Current-Sense Input. Connect the positive terminal of the current-sense resistor to 12SA+ using the Kelvin-sensing technique to ensure accurate current sensing.
39	12SA-	Slot A 12V Negative Current-Sense Input. Connect 12SA- to the negative side of the current-sense resistor using the Kelvin-sensing technique to ensure accurate current sensing.
40	12GA	Slot A 12V Gate-Drive Output. Connect 12GA to the gate of slot A's 12V MOSFET. At power-up, V _{12GA} is raised to the internal charge-pump voltage level by a constant current.

Triple PCI Express, Hot-Plug Controllers

Pin Description (continued)

MAX5957/MAX5958

PIN	NAME	FUNCTION
41	3.3SA+	Slot A 3.3V Positive Current-Sense Input. Connect the positive side of the current-sense resistor to 3.3SA+ using the Kelvin-sensing technique to ensure accurate current sensing.
42	3.3SA-	Slot A 3.3V Negative Current-Sense Input. Connect to the negative side of the sense resistor using the Kelvin-sensing technique to ensure accurate current sensing.
43	3.3GA	Slot A 3.3V Gate-Drive Output. Connect 3.3GA to the gate of slot A's 3.3V MOSFET. At power-up, V _{3.3GA} is charged to 5.5V above the 3.3V supply by a constant current derived from V _{12VIN} . V _{3.3GA} 's rise time is determined by the external gate capacitance.
44	$\overline{\text{FAULTA}}$	Open-Drain Fault Output Signal. $\overline{\text{FAULTA}}$ latches active low whenever slot A outputs are shut down due to a fault. A fault is either of: <ul style="list-style-type: none"> An overcurrent condition lasting longer than the overcurrent timeout. A device overtemperature condition. If the fault is detected in the main outputs, $\overline{\text{FAULTA}}$ must be reset by toggling the ONA input. If the fault is in the auxiliary output, $\overline{\text{FAULTA}}$ must be reset by toggling both ONA and AUXONA. For the autorestart version, $\overline{\text{FAULTA}}$ is reset when the part initiates the next power-on cycle.
45	$\overline{\text{PWRGDA}}$	Open-Drain Power-Good Output. $\overline{\text{PWRGDA}}$ goes low 160ms after all outputs of slot A reach their final value and the power MOSFETs are fully enhanced.
47	3.3AUXOA	Slot A 3.3V Auxiliary Power-Supply Output
50	3.3AUXOB	Slot B 3.3V Auxiliary Power-Supply Output
51	$\overline{\text{PWRGDB}}$	Open-Drain Power-Good Output. $\overline{\text{PWRGDB}}$ goes low 160ms after all outputs of slot B reach their final value and the power MOSFETs are fully enhanced.
52	$\overline{\text{FAULTB}}$	Open-Drain Fault Output Signal. $\overline{\text{FAULTB}}$ latches active low whenever the slot B outputs are shut down due to a fault. A fault is either of: <ul style="list-style-type: none"> An overcurrent condition lasting longer than the overcurrent timeout. A device over temperature condition. If the fault is detected in the main outputs, $\overline{\text{FAULTB}}$ must be reset by toggling the ONB input. If the fault is in the auxiliary output, $\overline{\text{FAULTB}}$ must be reset by toggling both ONB and AUXONB. For the autorestart version, $\overline{\text{FAULTB}}$ is reset when the part initiates the next power-on cycle.
53	3.3GB	Slot B 3.3V Gate-Drive Output. Connect 3.3GB to the gate of slot B's 3.3V MOSFET. At power-up, V _{3.3GB} is charged to 5.5V above the 3.3V supply by a constant current derived from V _{12VIN} . V _{3.3GB} 's rise time is determined by the external gate capacitance.
54	3.3SB-	Slot B 3.3V Negative Current-Sense Input. Connect to the negative side of the sense resistor using the Kelvin-sensing technique to ensure accurate current sensing.
55	3.3SB+	Slot B 3.3V Positive Current-Sense Input. Connect the positive side of the current-sense resistor to 3.3SB+ using the Kelvin-sensing technique to ensure accurate current sensing.
56	12GB	Slot B 12V Gate-Drive Output. Connect 12GB to the gate of slot B's 12V MOSFET. At power-up, V _{12GB} is raised to the internal charge-pump voltage level by a constant current.

Detailed Description

The MAX5957/MAX5958 triple hot-plug controllers are designed for PCIe applications. The devices provide hot-plug control for 12V, 3.3V, and 3.3V auxiliary supplies for three PCIe slots. The MAX5957/MAX5958s' logic inputs/outputs allow interfacing directly with the system hot-plug-management controller or through an SMBus with an external I/O expander. An integrated debounced attention switch and present-detect signals are included to simplify system design (Figure 1).

The MAX5957/MAX5958 drive six external n-channel MOSFETs to control the 12V and 3.3V main outputs. The 3.3V auxiliary outputs are controlled through internal 0.2Ω n-channel MOSFETs. Internal charge pumps provide a gate drive for the 12V outputs while the gate drive of the 3.3V output is driven by the 12V input supply. The 3.3V auxiliary outputs are completely independent from the main outputs with their own charge pumps.

Triple PCI Express, Hot-Plug Controllers

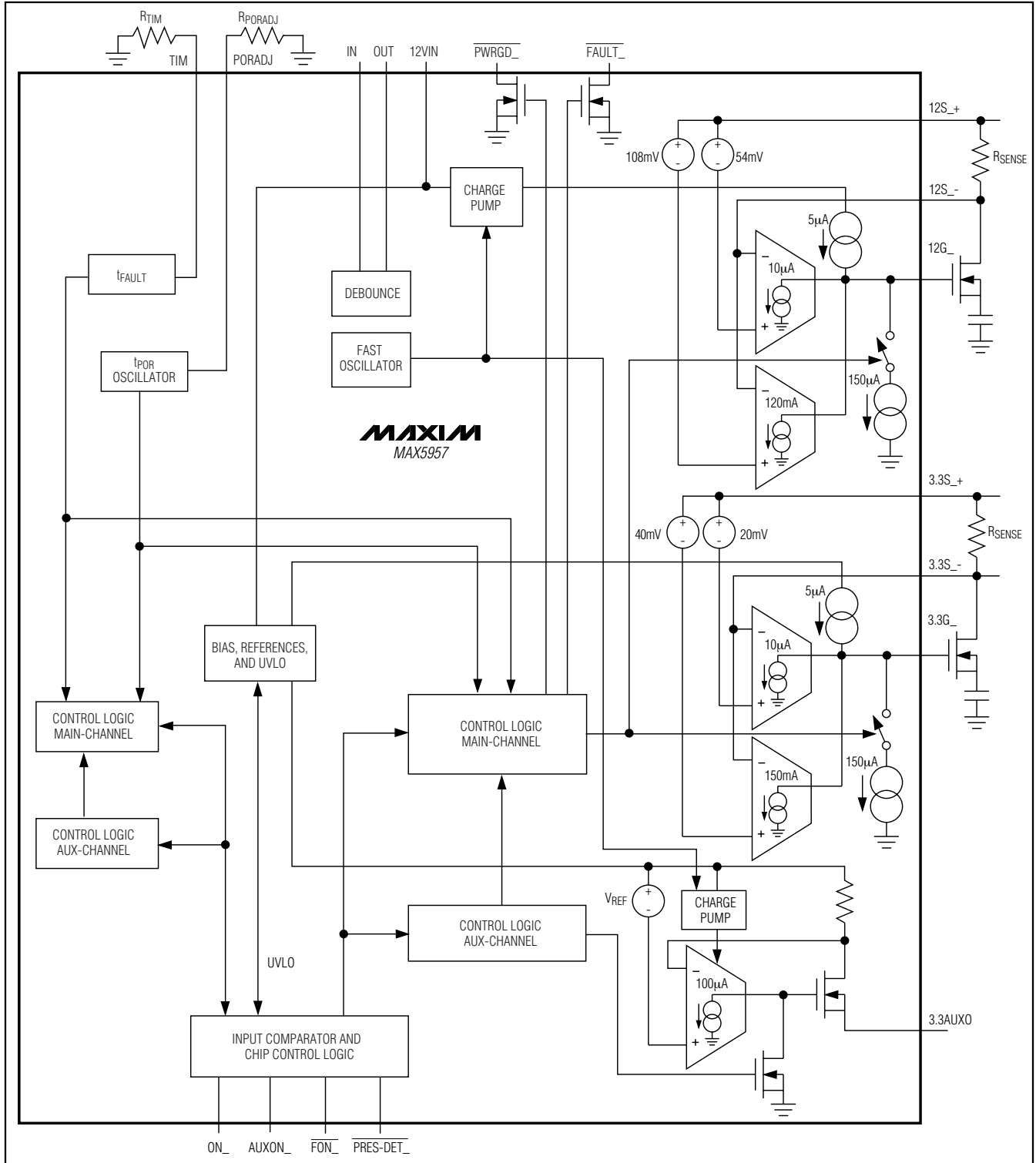

Figure 1. Single-Channel Internal Block Diagram

Triple PCI Express, Hot-Plug Controllers

At power-up, the MAX5957/MAX5958 keep all the external MOSFETs off until all supplies rise above their respective UVLO thresholds. These devices keep the internal MOSFETs off only until the 3.3VAUXIN supply rises above its UVLO threshold. Upon a turn-on command, the MAX5957/MAX5958 enhance the external and internal MOSFETs slowly with a constant gate current to limit the power-supply inrush current. The MAX5957/MAX5958 actively limit the current of all outputs at all times and shut down the corresponding channel if an overcurrent condition persists for longer than a resistor-programmable overcurrent timeout (see the *Fault Management* section). Thermal protection circuitry also shuts down all outputs if the die temperature exceeds +150°C. After an overcurrent or overtemperature fault condition, the MAX5957/MAX5958 latch off or automatically restart after a restart time delay.

The power requirement for PCIe connectors is defined by the PCIe card specification and summarized in Table 1.

Startup

The main supply outputs can become active only after all the following events have occurred:

- V_{3.3AUXIN} is above its UVLO threshold.
- V_{12VIN} and V_{3.3SA+} are both above their UVLO threshold.
- ON₋ is driven high.
- $\overline{\text{PRES-DET}}$ is low for more than 4ms.

The auxiliary supply output is made available only after the following events have occurred:

- V_{3.3AUXIN} is above its UVLO threshold.
- AUXON₋ is driven high.
- $\overline{\text{PRES-DET}}$ is low for more than 4ms.

The $\overline{\text{FON}}$ input overrides all other control signals and turns on the respective slot when driven low, as long as the UVLO thresholds have been reached. Table 2 summarizes the logic conditions required for startup. The auxiliary supply input powers the internal control logic and analog references of the MAX5957/MAX5958, so the main supplies cannot be enabled, if V_{3.3VAUXIN} is not present. When an output is enabled, a programmable startup timer (t_{SU}) begins to count the startup time duration.

The value of t_{SU} is set to 2x the fault timeout period (t_{FAULT}). RTIM externally connected from TIM to GND sets the duration of t_{FAULT}.

Table 1. Power Requirement for PCIe Connectors

POWER FAIL	X1 CONNECTOR	X4/8 CONNECTOR	X16 CONNECTOR
3.3V			
Voltage Tolerance	±9% (max)	±9% (max)	±9% (max)
Supply Current	3.0A (max)	3.0A (max)	3.0A (max)
Capacitive Load	1000µF (max)	1000µF (max)	1000µF (max)
12V			
Voltage Tolerance	±8% (max)	±8% (max)	±8% (max)
Supply Current	0.5A (max)	0.5A (max)	0.5A (max)
Capacitive Load	300µF (max)	1000µF (max)	2000µF (max)
3.3V AUXILIARY			
Voltage Tolerance	±9% (max)	±9% (max)	±9% (max)
Supply Current, Wake Enabled	375mA (max)	375mA (max)	375mA (max)
Supply Current, Nonwake Enabled	20mA (max)	20mA (max)	20mA (max)
Capacitive Load	150µF (max)	150µF (max)	150µF (max)

Triple PCI Express, Hot-Plug Controllers

Table 2. Control Logic Truth Table

ON_	AUXON_	$\overline{\text{FON}}$	$\overline{\text{PRES-DET}}$	12V_ AND 3.3V_ OUTPUTS	3.3VAUXO_ AUXILIARY OUTPUTS
X	X	Low	X	On	On
X	X	High	High	Off	Off
Low	Low	High	Low*	Off	Off
High	Low	High	Low*	On	Off
Low	High	High	Low*	Off	On
High	High	High	Low*	On	On

*PRES-DET_ high-to-low transition has a 4ms delay (t_{DEG}).

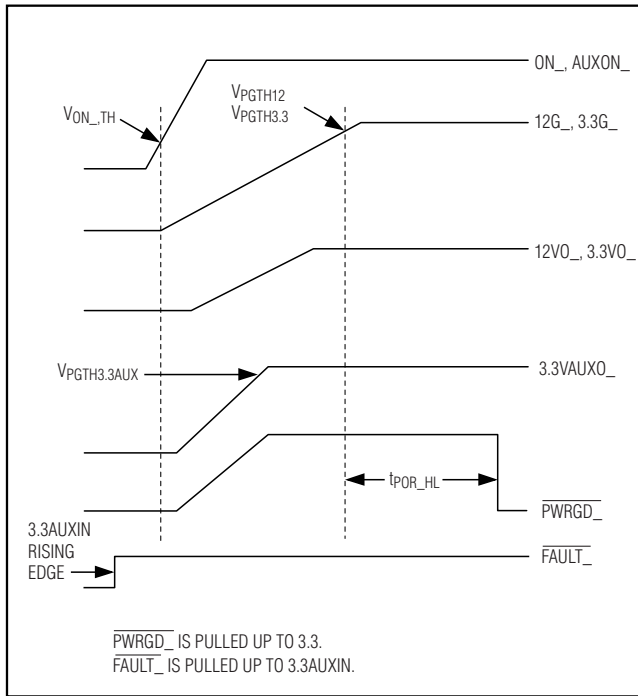

Figure 2. Power-Up Timing, No Fault

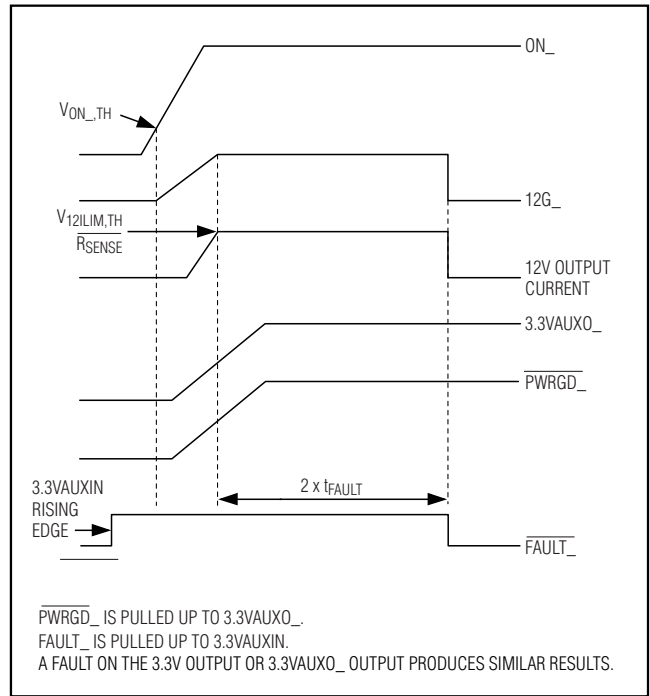

Figure 3. 12V Power-Up Timing (Turn-On into Output Overcurrent/Short Circuit)

Triple PCI Express, Hot-Plug Controllers

MAX5957/MAX5958

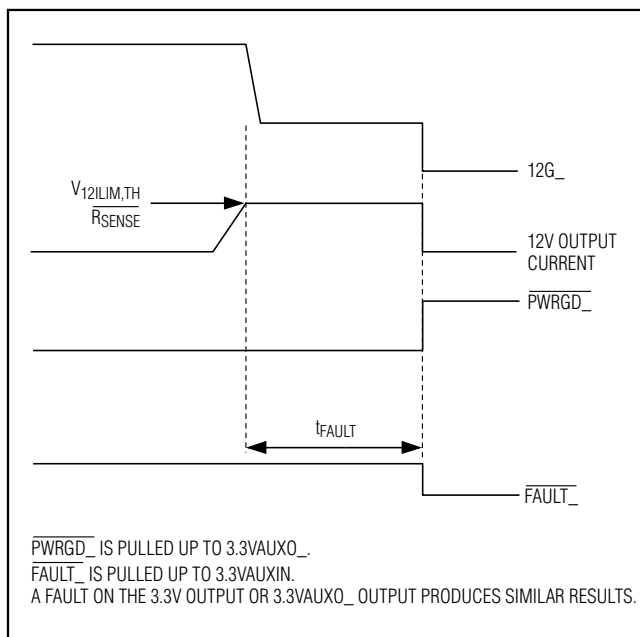

Figure 4. 12 Output Overcurrent/Short Circuit During Normal Operation

12V and 3.3V Outputs Normal Operation

The MAX5957/MAX5958 monitor and actively limit the current of the 12V and 3.3V outputs after the startup period. Each output has its own overcurrent threshold. If any of the monitored output currents rise above the overcurrent threshold for a period t_{FAULT} , $FAULT_$ asserts and the controller disengages both the 12V and 3.3V outputs for the particular slot (see the *Fault Management* section).

3.3V Auxiliary Output Normal Operation

The auxiliary output current is internally monitored and actively limited to the maximum current-limit value. An overcurrent fault condition occurs when the output current exceeds the overcurrent threshold for longer than t_{FAULT} . A fault on an auxiliary channel causes all supplies of the affected channel to be disabled after a programmable time period t_{FAULT} .

A fault condition on a main channel (V_{12VIN} or $V_{3.3VIN}$) causes all the channel's main outputs to shut down after the t_{FAULT} period and then either latch off or automatically restart after the $t_{RESTART}$ ($t_{RESTART} = 64 \times t_{FAULT}$) period, depending on the device version. A

fault on any of the channel's main outputs does not affect the auxiliary channel ($V_{3.3AUXIN}$).

Power-Good (PWRGD_)

Power-good ($PWRGD_$) is an open-drain output that pulls low a time (t_{POR_HL}) after all the outputs of the respective slot are fully on. All outputs are considered fully on when 3.3G_ has risen to $V_{PGTH3.3}$, 12G_ has risen to V_{PGTH12} , and $V_{3.3AUXO_}$ is less than $V_{PGTH3.3AUX}$. t_{POR_HL} is adjustable from 2.4ms to 1.5s by connecting a resistor from PORADJ to GND. See the *Setting the Power-On Reset and Timeout Period* (t_{POR_HL}) sections. Connect PORADJ to GND to completely skip the POR time delay for $PWRGD_$ assertion.

Thermal Shutdown

When the die temperature goes above (T_{SD}) +150°C, an overtemperature fault occurs and the MAX5957/MAX5958 shut down all outputs. The devices wait for the junction temperature to decrease below T_{SD} - hysteresis before entering fault management (see the *Fault Management* section).

Fault Management

A fault occurs when an overcurrent or 12G_ or 3.3G_ below the power-good threshold lasts longer than t_{FAULT} or when the device experiences an overtemperature condition:

- A fault on a main output (12V or 3.3V) shuts down both main outputs of the respective slot. The 3.3V auxiliary is not affected.
- A fault on the 3.3V auxiliary output shuts down all three outputs of the respective slot.

The MAX5957A/MAX5958A automatically restart from a fault shutdown after the $t_{RESTART}$ period while the MAX5957L/MAX5958L latch off. If an overcurrent fault occurred on a main output, bring ON_ low for at least t_{RESET} (100µs) and high again to reset the fault and restart the outputs. If the overcurrent fault occurred on an auxiliary output or an overtemperature fault occurred, bring both ON_ and AUXON_ low for a minimum of t_{RESET} to reset the fault. Toggle ON_ or only AUXON_ to reset the fault condition. If ON_ and AUXON_ are toggled before $t_{RESTART}$ time counting has elapsed, the MAX5957L/MAX5958L store the information and restart when the delay is finished. The MAX5957A/MAX5958A (autoretry versions) restart all channels automatically after $t_{RESTART}$.

Triple PCI Express, Hot-Plug Controllers

Debounced Logic Gate (INPUT_ and OUTPUT_)

INPUT1, INPUT2, and INPUT3 accept inputs from mechanical switches. The corresponding outputs are OUTPUT1, OUTPUT2, and OUTPUT3. OUTPUT_ is debounced for 4ms. When INPUT_ goes from high to low, OUTPUT_ goes low immediately and stays low for at least 4ms. After the debounce time, OUTPUT_ follows INPUT_. If INPUT_ goes from low to high, OUTPUT_ goes high immediately and stays high for at least 4ms. After the debounce time, OUTPUT_ follows INPUT_. Figure 5 shows the timing diagram describing the INPUT_/OUTPUT_ debounced feature.

Present-Detect and Forced-On Inputs (PRES-DET_, FON_)

PRES-DET_ input detects the PRSNT#2 pin on a PCIe connector. When the card is plugged in, PRES-DET_ goes low and allows the turn-on of the outputs of the respective slot after a 4ms debounced time. When the card is removed, an internal 50k Ω pullup resistor forces PRES-DET_ high and the respective slot is shut down with no delay. PRES-DET_ works in conjunction with ON_ and AUXON_ and only enables the device when ON_ and AUXON_ are high.

A logic-low on FON_ forces the respective slot (main supplies and auxiliary) to turn on regardless of the status of the other logic inputs, provided the UVLO thresholds are exceeded on all the inputs.

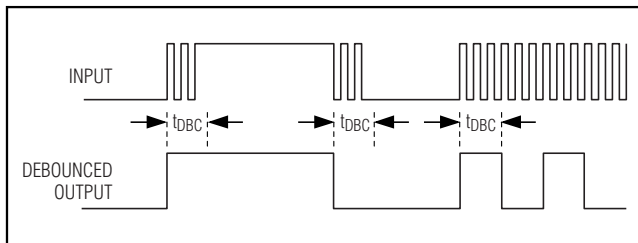

Figure 5. INPUT_ and OUTPUT_ Debounced Feature

Active Current Limits

Active current limits are provided for all three outputs of the three slots (slot A, slot B, and slot C). Connect a current-sense resistor between 12S_+ and 12S_- to set the current limit for the 12V outputs. The current limit is set to $54\text{mV} / R_{\text{SENSE}12}$. Connect a current-sense resistor between 3.3S_+ and 3.3S_- to set the current limit for the 3.3V main outputs to $20\text{mV} / R_{\text{SENSE}3.3}$. For the auxiliary output (3.3VAUXO_) the current limit is fixed at 450mA in the MAX5957 and 700mA in the case of the MAX5958.

When the voltage across RSENSE12 or RSENSE3.3 reaches the current-limit threshold voltage, the MAX5957/MAX5958 regulate the gate voltage to maintain the current-limit threshold voltage across the sense resistor. If the current limit lasts for t_{FAULT} , then an overcurrent fault occurs. The MAX5957/MAX5958 shut down both the 12V and 3.3V outputs and assert the FAULT_ output of the respective slot.

When the auxiliary output reaches the current limit for longer than t_{FAULT} , a fault occurs and the device shuts down all outputs and asserts FAULT of the respective slot.

UVLO Threshold

The UVLO thresholds prevent the internal auxiliary MOSFETs and the external main channel MOSFETs from turning on if $V_{12\text{VIN}}$, $V_{3.3\text{VIN}}$, and $V_{3.3\text{VAUXIN}}$ are not present. Internal comparators monitor the main supplies and the auxiliary supply and keep the gate-drive outputs (12GA, 12GB, 12GC, 3.3GA, 3.3GB, and 3.3GC) low until the supplies rise above their UVLO threshold. The 12V main supply is monitored at 12VIN and has a UVLO threshold of 10V. The 3.3V main supply is monitored at 3.3SA+ and has a UVLO threshold of 2.65V. The auxiliary supply is monitored at 3.3AUXIN and has a 2.65V UVLO threshold. For either main channels to operate, $V_{3.3\text{AUXIN}}$ must be above its UVLO threshold.

Triple PCI Express, Hot-Plug Controllers

MAX5957/MAX5958

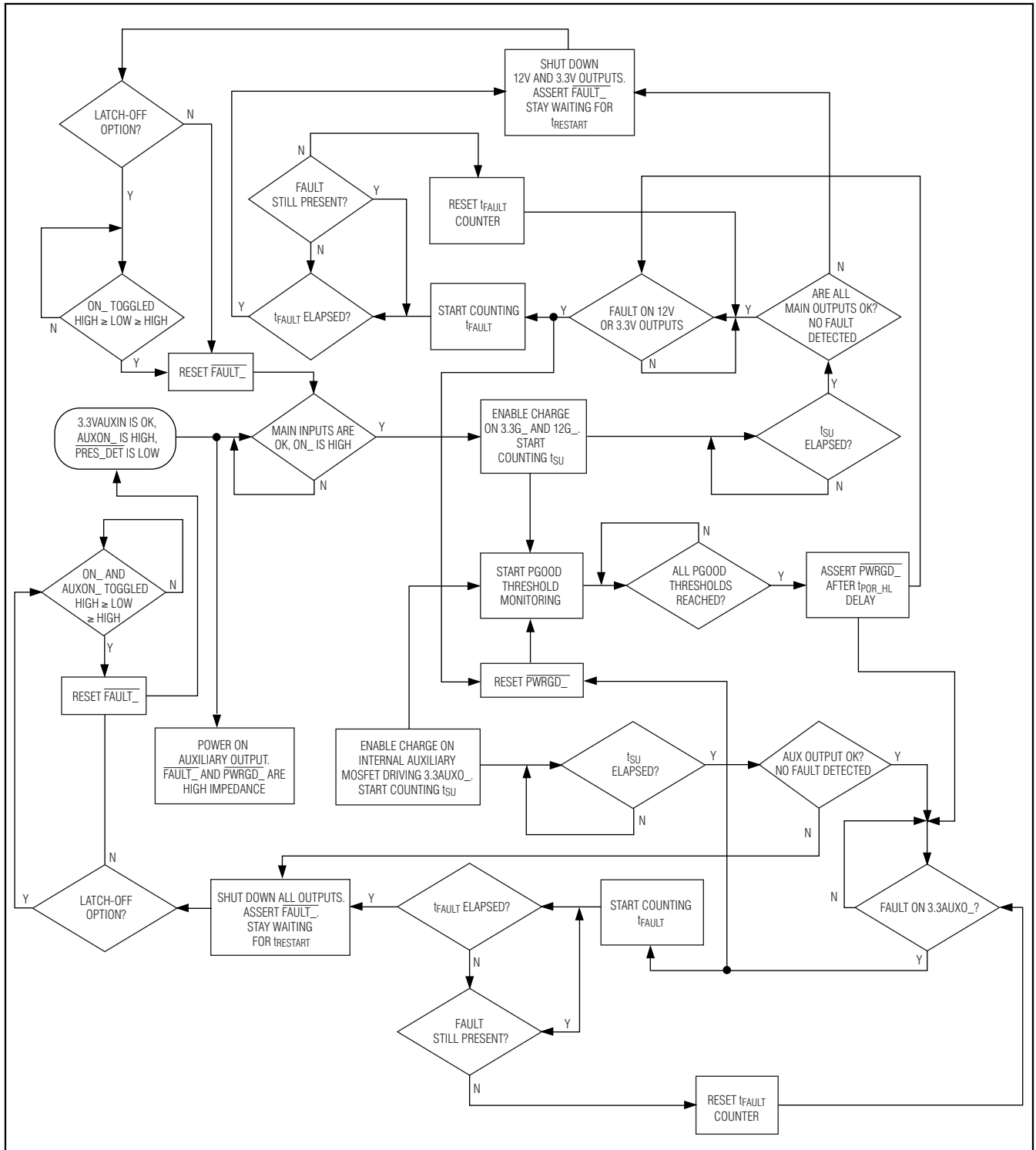

Figure 6. Fault Management Flowchart

Triple PCI Express, Hot-Plug Controllers

External MOSFET Gate Drivers (12G_ and 3.3G_)

The gate drive for the external MOSFETs is provided at 12GA, 12GB, 12GC, 3.3GA, 3.3GB, and 3.3GC. 12G_ is the gate drive for the 12V main supply and is boosted to 5.3V above V_{12VIN} by its internal charge pump. During turn-on, 12G_ sources 5 μ A into the external gate capacitance to control the turn-on time of the external MOSFET. During turn-off, 12G_ sinks 150 μ A from the external gate capacitance to quickly turn off the external MOSFET. During short-circuit events, an internal 120mA current sink activates to rapidly bring the load current into the regulation limits.

3.3G_ is the gate drive for the 3.3V main supply's MOSFET and is driven to 5.5V above the 3.3V main supply. The power for 3.3G_ is supplied from 12VIN and has no internal charge pump. During turn-on, 3.3G_ sources 5 μ A into the external gate capacitance to control the turn-on time of the external MOSFET. During turn-off, 3.3G_ sinks 150mA to quickly turn off the external MOSFET. During short-circuit events, an internal 120mA current sink activates to rapidly turn off the appropriate external MOSFET.

Auxiliary Supply (3.3VAUXIN)

3.3VAUXIN provides power to the auxiliary outputs as well as the internal logic and references. The drains of the internal auxiliary MOSFETs connect to 3.3AUXIN through internal sense resistors and the sources connect to the auxiliary outputs (3.3VAUXO_). Both MOSFETs have typical on-resistance of 0.2 Ω . Each channel's internal charge pump boosts the gate-drive voltage to fully turn on the internal n-channel MOSFETs. The auxiliary supplies have an internal current limit set to 450mA (MAX5957), 700mA (MAX5958).

Applications Information

Setting the Power-On Reset

t_{FAULT} is the time an overcurrent or overtemperature fault must remain for the MAX5957/MAX5958 to disable the main or auxiliary channels of a particular slot. Program the fault timeout period (t_{FAULT}) by connecting a resistor (R_{TIM}) from TIM to GND. t_{FAULT} can be calculated by the following equation:

$$t_{FAULT} = (166\text{ns} / \Omega) \times R_{TIM}$$

The t_{FAULT} programmed time duration must be chosen according to the total capacitance load connected to the 12G_ and 3.3G_ pins. To properly power up the main supply outputs, the following constraints need to be taken:

$$t_{SU} \geq (V_{GATE} \times C_{LOAD}) / I_{CHG}$$

where $t_{SU} = 2 \times t_{FAULT}$ and where:

- $I_{CHG} = 5\mu\text{A}$.
- $V_{GATE} = 4.8\text{V} + V_{12VIN}$ for 12G_ and $V_{GATE} = 6.8\text{V} + V_{3.3VIN}$ for 3.3G_.
- C_{LOAD} is the total capacitance load at the gate.

Maximum and minimum values for R_{TIM} are 500 Ω and 500k Ω , respectively. Leave TIM floating for a default t_{FAULT} of 10ms.

Timeout Period (t_{POR_HL})

t_{POR_HL} is the time from when the gate voltages of all outputs of a slot reach their power-good threshold to when $\overline{PWRGD_}$ pulls low. Program the POR timeout period (t_{POR}) by connecting a resistor (R_{PORADJ}) from PORADJ to GND. t_{POR_HL} can be calculated by the following equation:

$$t_{POR_HL} = (2.5\mu\text{s} / \Omega) \times R_{PORADJ}$$

Maximum and minimum values for R_{PORADJ} are 500 Ω and 500k Ω , respectively. Leave PORADJ floating for a default t_{POR} of 150ms. Connect PORADJ to GND in order to completely skip the power-on delay time prior to the $\overline{PWRGD_}$ assertion.

Component Selection

Select the external n-channel MOSFET according to the applications current requirement. Limit the switch power dissipation by choosing a MOSFET with an R_{DS_ON} low enough to have a minimum voltage drop at full load. High R_{DS_ON} causes larger output ripple if there are pulsed loads. High R_{DS_ON} can also trigger an external undervoltage fault at full load. Determine the MOSFET's power-rating requirement to accommodate a short-circuit condition on the board during start-up. Table 3 lists the MOSFETs and sense resistor manufacturers.

Triple PCI Express, Hot-Plug Controllers

MAX5957/MAX5958

Table 3. Component Manufacturers

COMPONENT	MANUFACTURER	PHONE	WEBSITE
Sense Resistor	Vishay-Date	402-564-3131	www.vishay.com
	IRC	704-264-8861	www.irctt.com
MOSFETs	Fairchild	888-522-5372	www.fairchildsemi.com
	International Rectifier	310-322-3331	www.irf.com
	Motorola	602-244-3576	www.mot-sps.com/ppd
	Vishay-Siliconix	—	www.vishay.com

Additional External Gate Capacitance

External capacitance can be added from the gate of the external MOSFETs to GND to slow down the dV/dt of the 12V and 3.3V outputs. The maximum gate capacitance load at 12G₋ and 3.3G₋ must be consistent with the conditions described in the *Setting the Power-On Reset* section.

Maximum Load Capacitance

Large capacitive loads at the 12V output, the 3.3V output, and the 3.3V auxiliary output can cause a problem when inserting discharged PCI cards into live backplanes. A fault occurs if the time needed to charge the capacitance of the board is greater than the typical startup time ($2 \times t_{\text{FAULT}}$). The MAX5957/MAX5958 withstand large capacitive loads due to their adjustable startup times and adjustable current-limit thresholds. Calculate the maximum load capacitance as follows:

$$C_{\text{LOAD}} < (t_{\text{SU}} \times I_{\text{LIM}}) / V_{\text{OUT}}$$

V_{OUT} is either the 3.3V output, the 12V output, or the 3.3V auxiliary output for slot A, slot B, or slot C.

Input Transients

The 12V input (12VIN), the 3.3V input (3.3SA+), and the 3.3V auxiliary (3.3AUXIN) must be above their UVLO thresholds before startup can occur. Input transients can cause the input voltage to sag below the UVLO threshold. The MAX5957/MAX5958 reject transients on the input supplies that are shorter than 4 μ s (typ).

Because some load fault conditions can cause voltage transients to propagate to the supply inputs with duration of greater than 4 μ s, it is recommended that a small Schottky diode be placed in series with the 12VIN pin connection, upstream of the 1 μ F bypass capacitor. This provides a hold-up supply that will prevent the 12VIN input from dropping below $V_{12\text{UVLO}}$ during severe transients. See the *Typical Application Circuit*.

Triple PCI Express, Hot-Plug Controllers

Typical Application Circuit

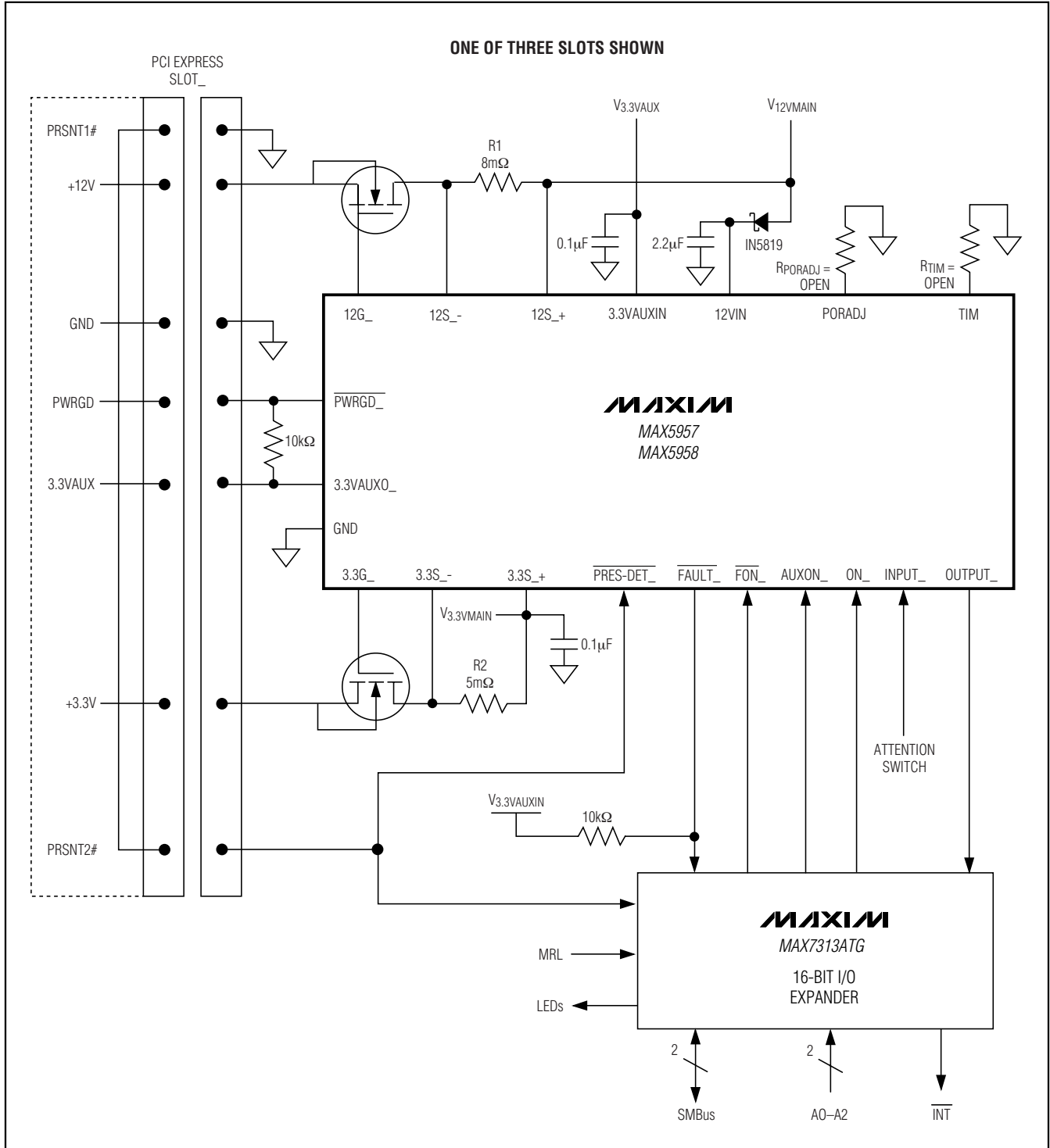

Triple PCI Express, Hot-Plug Controllers

Pin Configuration

MAX5957/MAX5958

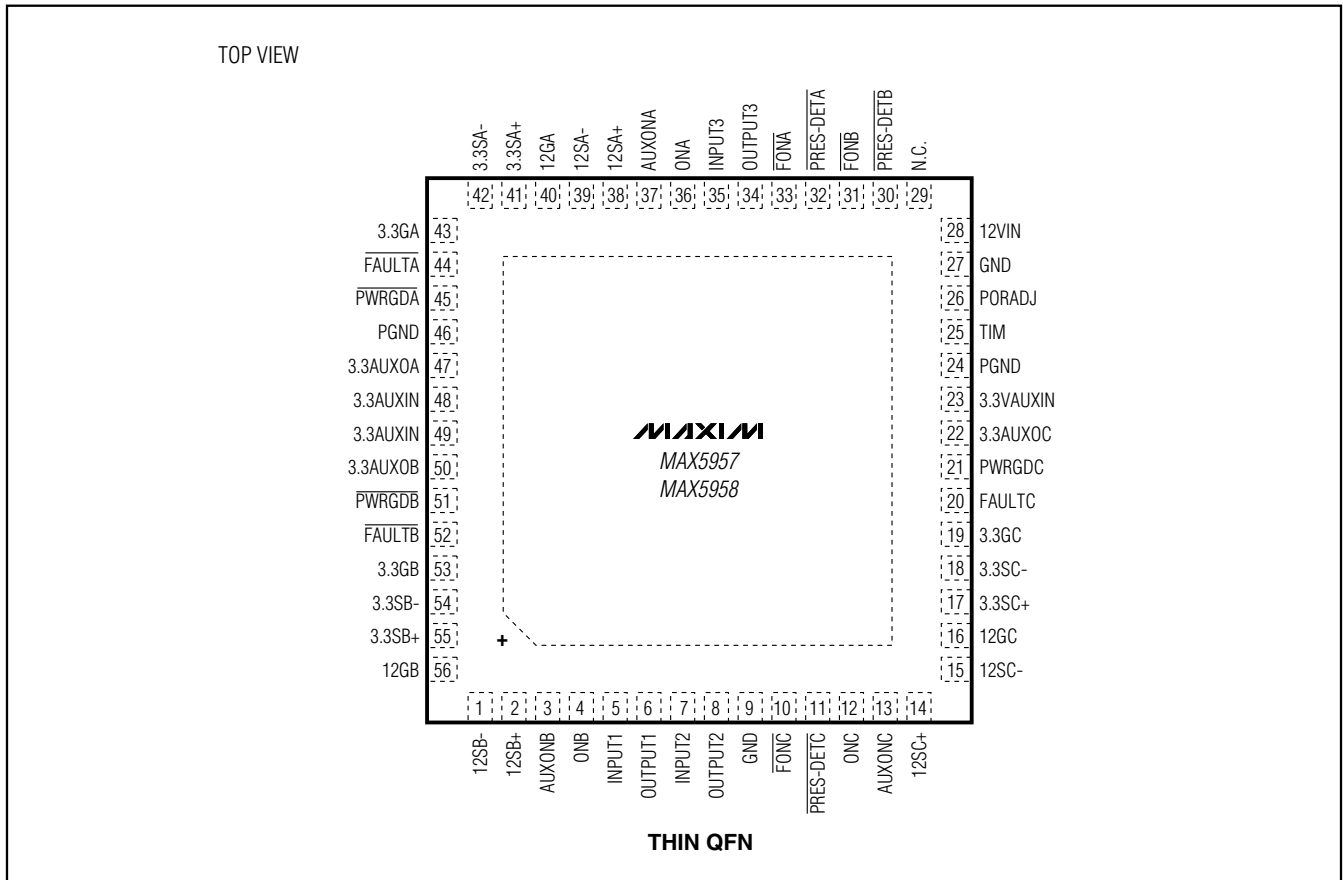

Chip Information

PROCESS: BiCMOS

Triple PCI Express, Hot-Plug Controllers

Package Information

(The package drawing(s) in this data sheet may not reflect the most current specifications. For the latest package outline information go to www.maxim-ic.com/packages.)

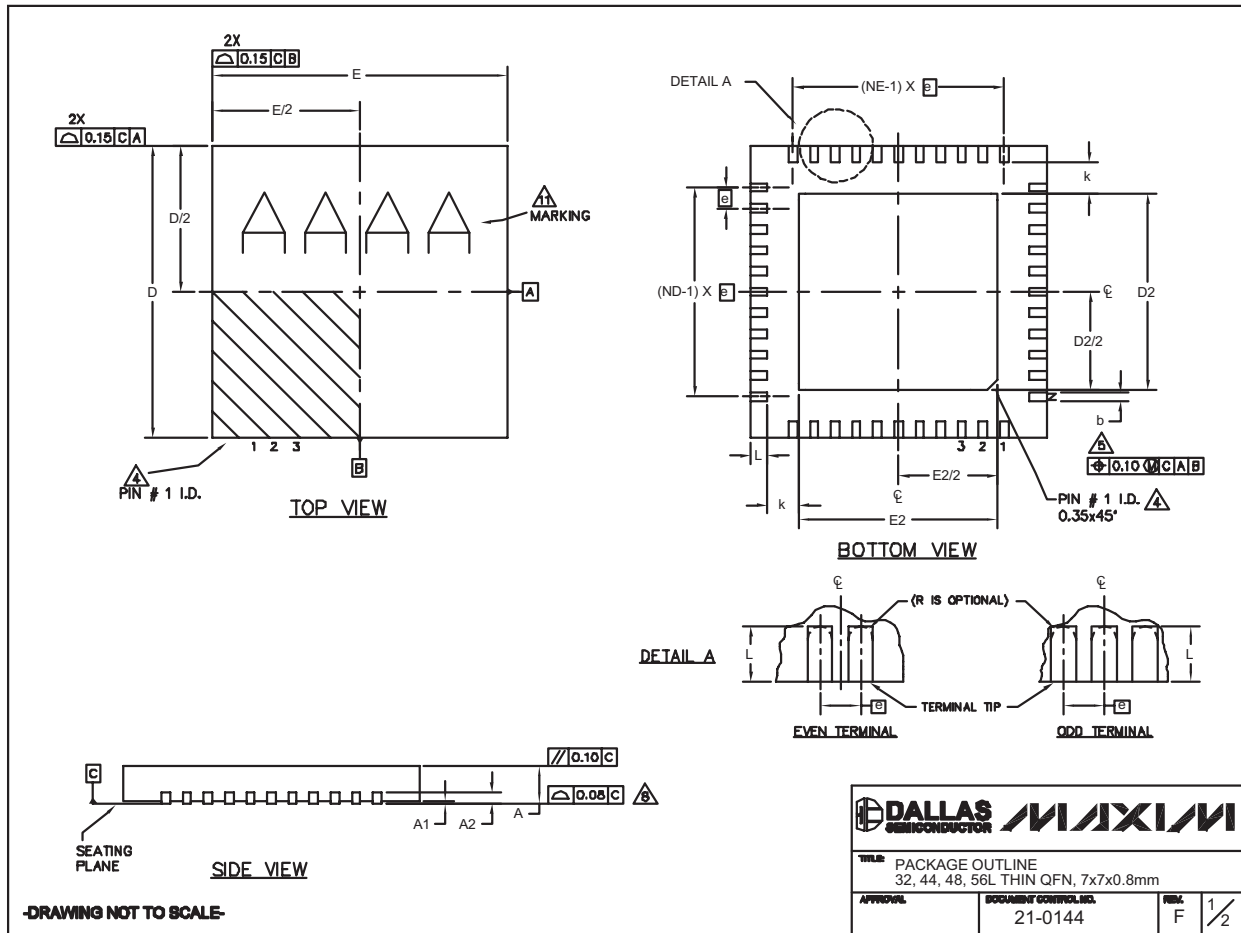

32, 44, 48L QFN.EPS

Triple PCI Express, Hot-Plug Controllers

Package Information (continued)

(The package drawing(s) in this data sheet may not reflect the most current specifications. For the latest package outline information go to www.maxim-ic.com/packages.)

MAX5957/MAX5958

COMMON DIMENSIONS																EXPOSED PAD VARIATIONS								
PKG	32L 7x7			44L 7x7			48L 7x7			CUSTOM PKG. (T4877-1) 48L 7x7			56L 7x7			PKG. CODES	DEPOPULATED LEADS	DZ			E2			JEDEC MO220 REV. C
	SYMBOL	MIN.	NOM.	MAX.	MIN.	NOM.	MAX.	MIN.	NOM.	MAX.	MIN.	NOM.	MAX.	MIN.	NOM.			MAX.	MIN.	NOM.	MAX.	MIN.	NOM.	
A	0.70	0.75	0.80	0.70	0.75	0.80	0.70	0.75	0.80	0.70	0.75	0.80	0.70	0.75	0.80	T3277-2	-	4.50	4.70	4.85	4.55	4.70	4.85	-
A1	0	0.02	0.05	0	0.02	0.05	0	0.02	0.05	0	0.02	0.05	0	0.02	0.05	T3277-3	-	4.55	4.70	4.85	4.55	4.70	4.85	-
A2	0.20 REF.			0.20 REF.			0.20 REF.			0.20 REF.			0.20 REF.			T4477-2	-	4.55	4.70	4.85	4.55	4.70	4.85	WKD-1
b	0.25	0.30	0.35	0.20	0.25	0.30	0.20	0.25	0.30	0.20	0.25	0.30	0.15	0.20	0.25	T4477-3	-	4.55	4.70	4.85	4.55	4.70	4.85	WKD-1
D	6.90	7.00	7.10	6.90	7.00	7.10	6.90	7.00	7.10	6.90	7.00	7.10	6.90	7.00	7.10	T4877-1**	13,24,37,48	4.20	4.30	4.40	4.20	4.30	4.40	-
E	6.90	7.00	7.10	6.90	7.00	7.10	6.90	7.00	7.10	6.90	7.00	7.10	6.90	7.00	7.10	T4877-3	-	4.95	5.10	5.25	4.95	5.10	5.25	-
e	0.65 BSC.			0.60 BSC.			0.50 BSC.			0.50 BSC.			0.40 BSC.			T4877-4	-	5.40	5.50	5.60	5.40	5.50	5.60	-
k	0.25	-	-	0.25	-	-	0.25	-	-	0.25	-	-	0.25	-	-	T4877-5	-	2.40	2.50	2.60	2.40	2.50	2.60	-
L	0.45	0.55	0.65	0.45	0.55	0.65	0.30	0.40	0.50	0.45	0.55	0.65	0.30	0.40	0.50	T4877-6	-	5.40	5.50	5.60	5.40	5.50	5.60	-
N	32			44			48			44			56			T4877-7	-	4.95	5.10	5.25	4.95	5.10	5.25	-
ND	8			11			12			10			14			T4877M-1	-	5.40	5.50	5.60	5.40	5.50	5.60	-
NE	8			11			12			12			14			T4877M-6	-	5.40	5.50	5.60	5.40	5.50	5.60	-
																T4877M-B	-	5.40	5.50	5.60	5.40	5.50	5.60	-
																T5677-1	-	5.40	5.50	5.60	5.40	5.50	5.60	-
																T5677-2	-	5.40	5.50	5.60	5.40	5.50	5.60	-

** NOTE: T4877-1 IS A CUSTOM 48L PKG. WITH 4 LEADS DEPOPULATED. TOTAL NUMBER OF LEADS ARE 44.

NOTES:

- DIMENSIONING & TOLERANCING CONFORM TO ASME Y14.5M-1994.
- ALL DIMENSIONS ARE IN MILLIMETERS. ANGLES ARE IN DEGREES.
- N IS THE TOTAL NUMBER OF TERMINALS.
- THE TERMINAL #1 IDENTIFIER AND TERMINAL NUMBERING CONVENTION SHALL CONFORM TO JEDEC 95-1 SPP-012. DETAILS OF TERMINAL #1 IDENTIFIER ARE OPTIONAL, BUT MUST BE LOCATED WITHIN THE ZONE INDICATED. THE TERMINAL #1 IDENTIFIER MAY BE EITHER A MOLD OR MARKED FEATURE.
- DIMENSION b APPLIES TO METALLIZED TERMINAL AND IS MEASURED BETWEEN 0.25 mm AND 0.30 mm FROM TERMINAL TIP.
- ND AND NE REFER TO THE NUMBER OF TERMINALS ON EACH D AND E SIDE RESPECTIVELY.
- DEPOPULATION IS POSSIBLE IN A SYMMETRICAL FASHION.
- COPLANARITY APPLIES TO THE EXPOSED HEAT SINK SLUG AS WELL AS THE TERMINALS.
- DRAWING CONFORMS TO JEDEC MO220 EXCEPT THE EXPOSED PAD DIMENSIONS OF T4877-1/-3/-4/-5/-6 & T5677-1.
- WARPAGE SHALL NOT EXCEED 0.10 mm.
- MARKING IS FOR PACKAGE ORIENTATION REFERENCE ONLY
- NUMBER OF LEADS SHOWN ARE FOR REFERENCE ONLY

-DRAWING NOT TO SCALE-

TITLE: PACKAGE OUTLINE 32, 44, 48, 56L THIN QFN, 7x7x0.8mm	
APPROVAL:	DOCUMENT CONTROL NO. 21-0144
REV. F	2/2

Maxim cannot assume responsibility for use of any circuitry other than circuitry entirely embodied in a Maxim product. No circuit patent licenses are implied. Maxim reserves the right to change the circuitry and specifications without notice at any time.

Maxim Integrated Products, 120 San Gabriel Drive, Sunnyvale, CA 94086 408-737-7600 25